



# OfficeRight™ Document Inserting System DI380



**Operator Guide**  
International English Version



# Table of Contents



## Chapter 1 Introduction

Safety .....	1-1
To The Operator .....	1-2
Machine Configurations.....	1-2
Machine Identification.....	1-4
Control Panel.....	1-6

## Chapter 2 Operation

About this Chapter.....	2-1
Connecting Power .....	2-1
Select a Job.....	2-2
Run a Trial Piece .....	2-3
Start Machine Operation.....	2-3
Setting the Sheet Feeders.....	2-4
Setting the Envelope Feeder.....	2-6
Setting the Insert Feeder .....	2-6
Filling the Sealer.....	2-8
Adjusting the Stacker.....	2-8
Programming Jobs .....	2-9
Creating a New Job.....	2-9
Confirming the Job Setup.....	2-20
Testing the Job .....	2-21
Changing an Existing Job.....	2-22
Deleting a Job.....	2-22

# ***Table of Contents***

---

## **Chapter 3 Optical Mark Recognition (OMR)**

OMR Availability .....	3-1
What is OMR? .....	3-1
A Brief Overview of OMR on your Machine .....	3-1
Levels of OMR on the System.....	3-2
OMR Mark Positions.....	3-2
OMR Specifications .....	3-3
OMR Marks Available .....	3-6
OMR Mark Grouping .....	3-8
Programming an OMR Job.....	3-10
Adjustment of OMR Scanner.....	3-16
OMR Troubleshooting.....	3-18

## **Chapter 4 Reference**

Changing the Display Language .....	4-1
Clearing Material .....	4-1
General Troubleshooting .....	4-5
Error Messages .....	4-10
Material Specifications.....	4-13
Machine Specifications.....	4-17

## Safety

In some countries the equipment is supplied with a moulded mains lead and plug. In other countries, or if the supplied lead is not used, the following information applies:

1. An approved mains lead for the country concerned must be used.
2. As the colours of the wires in the mains lead of this equipment may not correspond with the coloured markings identifying the terminals in your plug, proceed as follows:
  - The wire which is coloured green and yellow must be connected to the terminal in the plug which is marked with the letter “E” or by the earth symbol  $\perp$  or coloured green or green and yellow.
  - The wire which is coloured blue must be connected to the terminal which is marked with the letter “N” or coloured black.
  - The wire which is coloured brown must be connected to the terminal which is marked with the letter “L” or coloured red.
3. The wires in the supplied mains lead are coloured in accordance with the following code:

Green and Yellow	-	Earth
Blue	-	Neutral
Brown	-	Live



**WARNING:**

**THIS EQUIPMENT MUST BE EARTHED**

The socket outlet should be near to the equipment and should be easily accessible.

To comply with health and safety standards, operators must observe all local standard safety precautions relating to the operation of office equipment. In particular, **DO NOT** remove covers from the machine. Refer all servicing to qualified personnel.

Keep hands, jewellery, ties, long hair, etc. away from moving parts.

# 1 • Introduction

---

## To the Operator

Your new Folding/Inserting Machine has an easy to follow user interface which makes it simple to set up, whilst offering the following features:

- Envelope seal/no seal option
- Fully automatic material separation on Sheet Feeders
- Fully automatic settings on Fold Plates
- Fully automatic envelope separation
- Fully automatic Double Document Detection when selected
- Fold only option (fold without insertion)
- Manually fed semi-automatic insertion of single and multiple sheet collations
- Option of single fold, letter (C) fold, accordion (Z) fold or double fold
- Job recall facility.
- Linked feeding (3 station machines only)

## Machine Configurations

The following machine configurations are available:

- 1 Station – One Sheet Feeder Only
- 2 Station – One Sheet Feeder and an Insert Feeder
- 3 Station – Two Sheet Feeders and an Insert Feeder

**IMPORTANT:** Model and feature availability varies by country. Contact your machine supplier for more information.

This guide covers all models and features. Inclusion within this guide does not guarantee availability of a particular model or feature within your country.

The processing speed will vary depending on machine configuration. See 'Specifications' in Chapter 4 for further details.

The system can be equipped with OMR (Optical Mark Recognition) functionality either direct from the factory or as an added option after purchase.

An OMR mark is normally a dark solid line on a sheet of light coloured paper that is perpendicular to the direction of travel of the paper. This line must be sufficiently thick and dense to trigger the OMR scanner on the system.

The OMR scanner, working with the OMR system software, checks for one or more different OMR marks on a document while it is fed through the system. The tracking of these OMR marks by the system increases the chance that a set of sheets which belong together (a set) actually stays together throughout the inserting process.

OMR equipped models are fitted with scanning heads on each of the sheet feeders.

Full details of using the OMR functions are given in Chapter 3 of this guide.

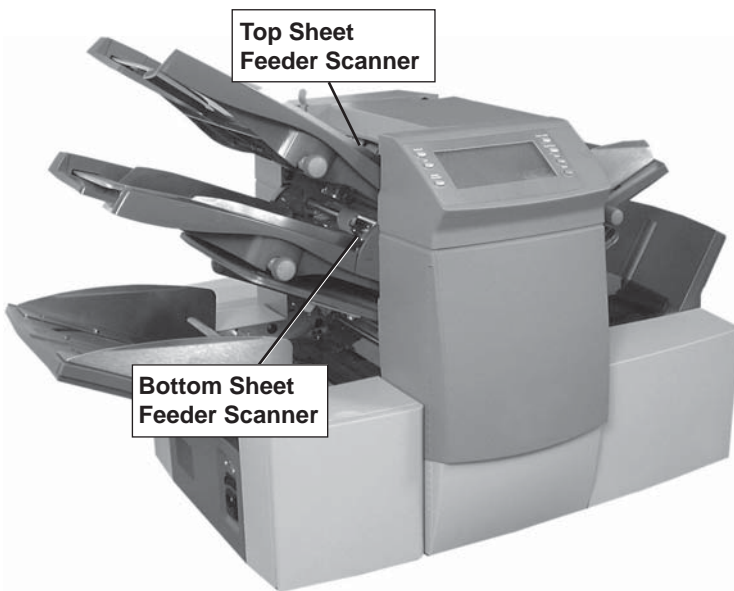

# 1 • Introduction

---

## Machine Identification

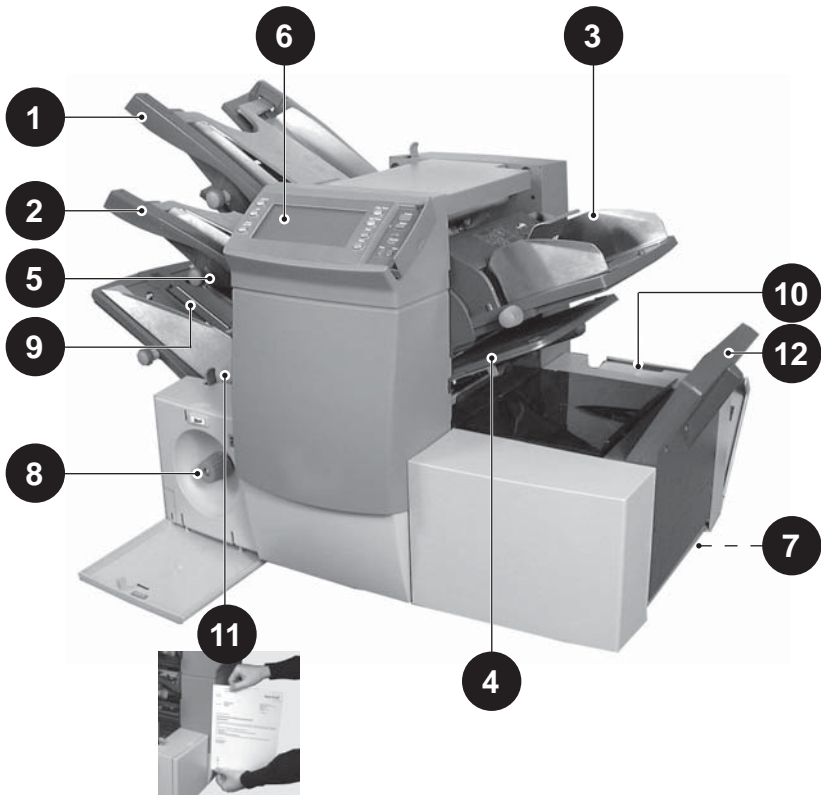

- 1 Sheet Feeder 1** This feeder is intended for feeding material that requires folding.

In addition, Sheet Feeder 1 can be set to 'Manual Feed'. In this mode, stapled sets of up to 5 sheets may be run. The machine waits for each set to be manually fed into Sheet Feeder 1 before folding and inserting the set automatically. See the Specifications section of this guide for full details of the sets possible.

- 2 Sheet Feeder 2** For feeding material that requires folding. Its functions are similar to Sheet Feeder 1 but 'Manual Feed' is NOT available from this feeder.



- 3 Insert Feeder** Use this feeder to add additional inserts to your envelope. Material fed from this feeder cannot be folded by the inserter. However, this feeder is especially suited to feeding pre-folded or thicker inserts.
- 4 Fold Plates 1 and 2** These units are used to create the desired fold in material fed from the Sheet Feeder(s). The Fold Plates are automatically set from the Control Panel.
- 5**
- 6 Display/Control Panel** This is where you enter commands and where the machine informs you of its status with the use of symbols and icons. Full details of each button function are given on the following page.
- 7 Drop Stacker or Output Device** (*not illustrated*)  
A fold down stacker is located at the exit from the machine to collect the finished Mail Pieces. This unit can be latched against the machine when not in use. Alternatively, a range of power stackers are available which offer greater capacity than the standard Drop Stacker.  
  
A Mailing Machine Interface can be fitted in place of a stacker which automatically transports Mail Pieces to a Pitney Bowes Mailing Machine for postal 'franking'.
- 8 Manual Advance Knob** The Manual Advance Knob is located inside an opening cover at the lower centre of the machine. It can be used to manually turn the machine mechanisms to assist in clearing a material stoppage.
- 9 Envelope Feeder** This feeder feeds envelopes into the inserting area where they are filled with the material requested from the other feeder(s).
- 10 Sealer Bottle** The sealer bottle is located inside an opening cover at the front right side of the machine. It provides sealing solution to the Envelope Sealer.
- 11 Measuring Scale** The scale is located on the left side of the machine near the sheet feeders as an aid in measuring material and envelopes.
- 12 Envelope Inverter** This unit exits the envelope into the stacker face up.

# 1 • Introduction

---

## Control Panel



### Control Panel Buttons

**Default** Press this button to return the machine to its default or 'standard' settings. These settings come pre-configured from the factory but can be modified to suit your needs by a Service Engineer.

**Job** Press to step through the jobs you have programmed into the machine's memory. The machine has the ability to be programmed by the operator with up to 20 jobs. See page 2-9 for details of programming jobs.

**Reset Counter** Press this button to reset the item or batch counter.

**Clear Deck** Pressing this button will jog material through and out of the system. It can be used to clear the machine ready for automatic operation after a stoppage has occurred etc.

**Trial Piece** This button is used to run a single test piece so that you can check machine setup. A trial piece must be run before automatic operation can be commenced using the **Start** button. If double detection is in use, the machine sets itself automatically as it runs the trial piece. This envelope will be unsealed and counted as one item.

**Start** Starts automatic operation.

**Stop** Stops automatic operation at the end of the next cycle.

**Delete** Used in setup mode to delete a programmed job from memory.

**Setup** When pressed, the machine enters setup mode. This mode allows you to program jobs into memory for instant recall using the **Job** button.

**Change + -** In setup mode, used to select options or set values of machine settings.

**Prev. ◀ ▶ Next** In setup mode, used to step backwards/forwards through the various job settings.

**Display Symbols**



Used on Sheet Feeders to signify that the feeder is on **without** double detection.



Used on Sheet Feeders to signify that the feeder is on **with** double detection.



Used on Insert Feeder to signify that the feeder is on **without** double detection.

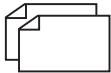

Used on Insert Feeder to signify that the feeder is on **with** double detection.



Used on Sheet Feeder 1 to signify that the feeder is set for manual feed.



Used on Envelope Feeder to signify that the feeder is on.



Indicates the setting (from 1 to 5) of the envelope stop.



Indicates that the sealer bottle needs refilling.



Indicates the envelope depth.



Indicates that the sealer unit is off (envelopes not sealed).

# 1 • Introduction

---

## Display Symbols (continued)



Indicates that the sealer unit is on (automatic envelope sealing).

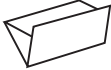

Indicates a 'C' - Letter fold is selected.

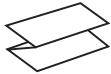

Indicates a 'Z' - Accordion fold is selected.

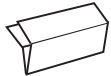

Indicates a double fold is selected.

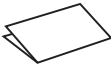

Indicates a single fold is selected.

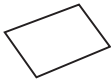

Indicates a no-fold insert operation.



Indicates a material stoppage. The position of this symbol in the display indicates where the stoppage has occurred.



Call your machine supplier for service.

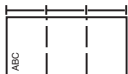

Indicates the paper size, address orientation and fold(s) set for Sheet Feeder.



Indicates a material stoppage in a 'downstream' device, such as a power stacker or Mailing Machine Interface (MMI).

### About this Chapter

This chapter explains operation of the machine, assuming the job to be run is already programmed into the system.

If the job has not been programmed, refer to 'Programming Jobs' on page 2-9.

### Connecting Power



**Read the safety information on page 1-1 before connecting the machine.**

Connect the power cord to the socket on the left side of the machine.

Plug the power cord into a suitable power outlet. Make sure the power outlet is near the machine and is easily accessible.

Turn the power switch ON.

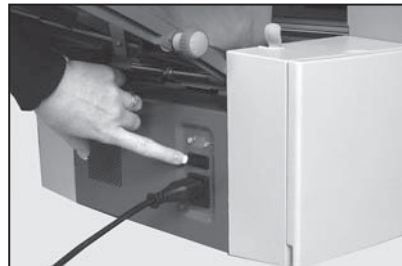

## 2 • Operation

---

### Select a job

When the machine is turned ON, the display will show the last job run and 'Trial Piece Required'.

Press the **Job** button until the job you require is displayed, or press **Default** if you want to run the machine with your 'standard' job settings.

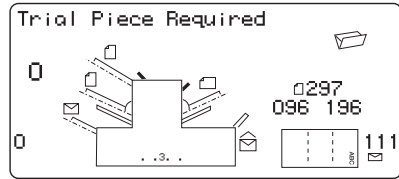

**Note:** The Default Job can be altered only by a Service Engineer.

If you have material loaded, press **Trial Piece**. The machine will set itself and run a test piece for you to check.

If you don't have material loaded, do this now, then return to this section. Loading feeders etc. is covered on pages 2-4 to 2-7.

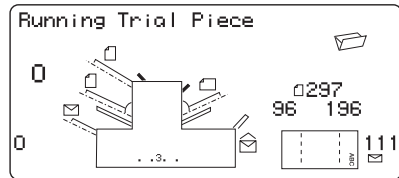

### Note:

You may have selected a 'Manual Feed' job where Sheet Feeder 1 is set for manual feed of collated sets. If this is the case, the Sheet Feeder should not be loaded, as the collated sets are fed one at a time as required by the machine.

However, the lever shown in the illustration should be pulled back to open the feed mechanism ready for manual feed operation. Remember to return this lever to its normal position when you use the feeder for automatic operation.

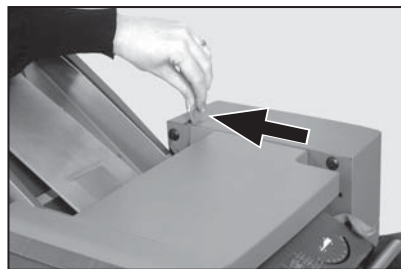

### Run a Trial Piece

Once material is in place, press **Trial Piece** so that you can check the setup is correct.

Minor changes to the job settings can be made at this stage if the trial piece needs 'fine tuning'. Enter setup as described on page 2-9, then use the **Prev** (◀), **Next** (▶) and **Change (+/-)** buttons as required to modify job settings. When you have made the necessary changes, press **Setup** again to return to run mode. The job will be saved with the new settings.

#### Notes:

1. When using Linked Feeding, **both** Sheet Feeders must be loaded before a Trial Piece is run.
2. If you load material during a run which seems to have different characteristics (weight, colour shade, etc.), or if you have any problems with double detect, run another Trial Piece. This allows the machine to recalibrate the double detect function for the new material in case the batches vary slightly.

### Start machine operation

Press **Start** to commence automatic operation.

The machine will operate until either material runs out or the **Stop** button is pressed.

**Note:** If the machine is set for Linked Feeding, the display will show: **1 > 2 > 1**

This confirms that feeding will automatically switch between Sheet Feeders. See page 2-13 for more details.

## 2 • Operation

---

### Setting the Sheet Feeders

1. Adjust the side guides to the width of the material being fed, then back-off a quarter turn on the side guide control. This will set the correct clearance between the guides and the material.



2. Take the stack of paper and aerate it to ensure the individual sheets are not stuck together.

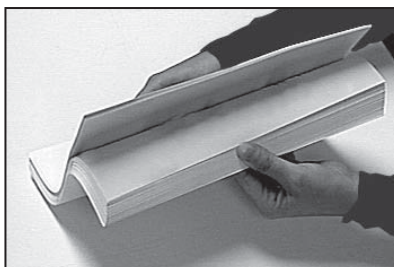

3. Jog the stack back into alignment. The Sheet Feeders take the paper stack aligned in a similar way to a photocopier paper cassette.

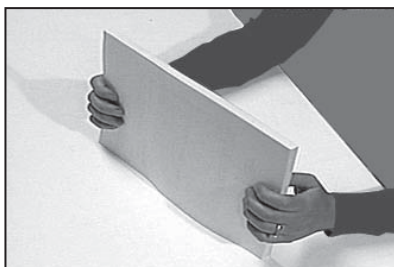

4. The display will indicate the correct orientation of the paper.

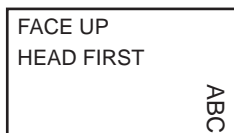



5. Place the paper stack onto the feed deck. Allow the deck to move down and the top of the paper stack to slide under the feed roller.



**Note:** When using both Sheet Feeders with accordion fold, Sheet Feeder 2 must be used for the prime (address bearing) document.

## 2 • Operation

---

### Setting the Envelope Feeder

Envelope Feeder feeds the Outer Envelope for the inserting job being run.

1. Adjust the side guides to the width of the envelopes being fed, then back-off half a turn on the side guide control. This will set the correct clearance between the guides and the envelopes.



2. Aerate the stack of envelopes to be run.

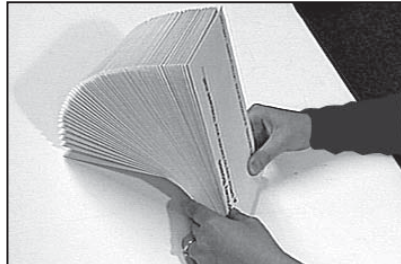

3. Place them on the feed deck with the flaps up and trailing. **The lead edge of the first envelope should be under the front feed roller and the stack of envelopes should be 'shingled' on the deck as shown.**



Let the 'wedge' slide down behind the stack so that the envelopes are supported.

### Setting the Insert Feeder

1. Adjust the side guides to the width of the material being fed, then back-off a quarter turn on the side guide control. This will set the correct clearance between the guides and the material.



- Refer to the 'label' located on the Insert Feeder. Compare your insert with the diagram. Read off the settings for the Insert Feeder blue lever (numbers 1 to 9) and the separator shield (letters A to D).

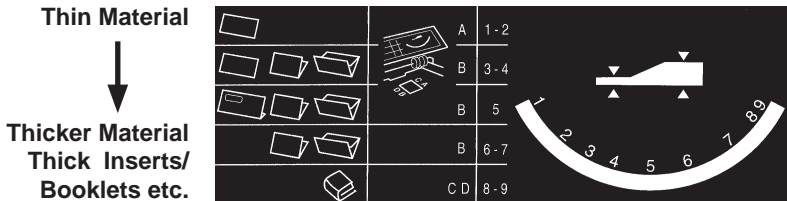

- Set the blue lever to the number required.



- Set the separator shield to the letter required.

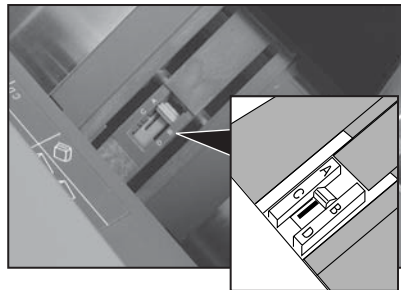

- Fan the inserts to be run and place them onto the feed deck. Loading orientation can vary depending on the actual inserts being run. However, generally, inserts should be loaded as follows:

Slip	Face up, bottom edge first
Reply Envelope	Face up, top edge first
Pre-Folded	Face up, closed edge first
Booklet	Face up, bound edge first

Let the 'wedge' slide down behind the stack so that the inserts are supported.



## 2 • Operation

---

### Filling the sealer

When the sealer unit needs refilling, the **Add Sealing Solution** symbol will flash in the display.



Add Sealing Solution or water in the following way:

**Note:** Sealing Solution is recommended to minimise growth of algae and scale build-up.

Hinge open the Sealer Bottle Cover located at the rear right hand side of the machine. Remove the bottle.

Fill the bottle up to the level indicated.

Refit the Sealer Bottle and close the cover.



**Note:** If the sealer unit has been allowed to completely empty, you should allow time for solution to soak through the sealer mechanism.

### Adjusting the Stacker

The Drop Stacker can be adjusted to suit the material being run.

Lift the lever at the rear of the stacker and adjust the stacker to one of the preset positions. Lower the lever to lock the stacker into position.

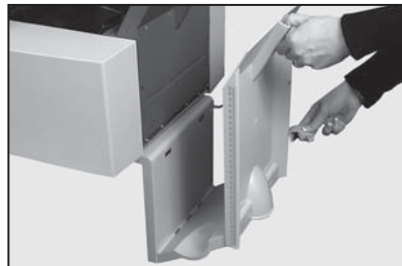

When not in use, the stacker can be raised and latched vertically against the exit area of the machine.

### Programming jobs

Your machine has the ability to be programmed with jobs which can be recalled at the touch of a button.

All models have 20 Operator programmable jobs plus 1 default job set by the Service Engineer.

### Creating a new job

This section takes you step-by-step through the process of setting up a new job and saving it in the memory.

Throughout the programming sequence, an asterisk (\*) will flash on the display next to the item being set. The **Prev** (◀) and **Next** (▶) buttons are used to step forward or backwards through the settings available. Once the item is displayed, the **Change (+/-)** buttons are used to select the option or value you want.

**Note:** The machine can be equipped with OMR (Optical Mark Recognition) functionality either direct from the factory or as an added option after purchase. To programme an OMR job, go to page 3-10 of this guide. To programme a non-OMR job, continue by entering the 'Setup Mode'...

### Entering the Setup Mode

Open the hinged cover to the right of the display. This will expose the setup buttons.

Press **Setup**. The indicator will light and the machine will ask for an access code. This code prevents the machine's settings being changed by unauthorised personnel.

Use the **Change (+/-)** buttons to select the access code **71**.

Press **Next** (▶) to advance to the next setting...

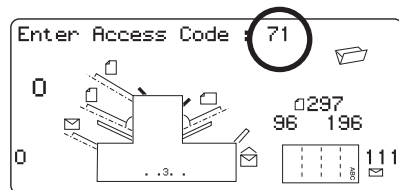

## 2 • Operation

---

### Choosing the new job number

The machine will ask for the job number you wish the new settings to be stored under. Use the **Change (+/-)** buttons to display the job number you want.

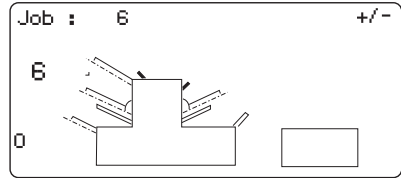
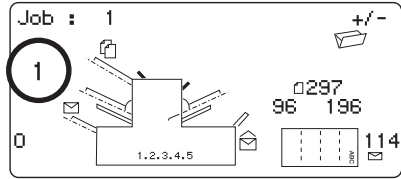

#### Notes:

- If you use an existing job number, the old settings will be overwritten by the new settings you are about to make.
- If you want to find a currently unused job number, press **Change (+/-)** until you see a job where the display shows no symbols alongside the feeders or in the fold setup area. This means the job is currently empty.

Press **Next (▶)** to advance to the next setting...

### OMR

On models equipped with OMR **ONLY**, you will now be asked to select the OMR mode. For a non-OMR job, use **Change (+/-)** to select *OMR off* (if you wish to programme an OMR job, see page 3-10).

Press **Next (▶)** to advance to the next setting...

## Fold Type

Select the type of fold.

Press **Change (+/-)** until you see the option you want:

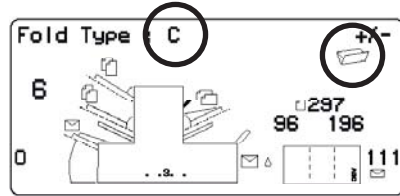

**C - Letter**

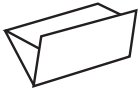

**Z - Accordion**

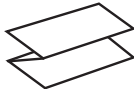

**Double**

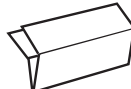

**Single**

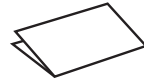

**Note:** For accumulation jobs, **DO NOT** manually change the automatically set fold length dimensions at the 'Fold A' and 'Fold B' settings on pages 2-17 and 2-18.

When the fold type is selected, the display will indicate the correct orientation of the paper for loading into the feeders:

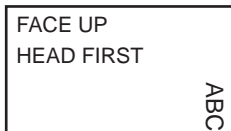

When the fold type is set as required, press **Next (▶)** to advance to the next setting...

## 2 • Operation

---

### Setting the Accumulation Function

Accumulation, if selected, allows multiple sheets to be fed from the SAME feeder into the envelope.

Press **Change (+/-)** until you see the option you want.

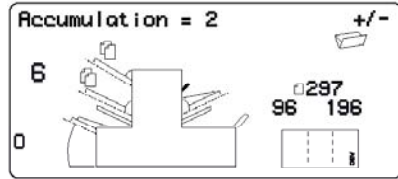

#### **Accumulation: OFF**

Accumulation is turned off for this job.

#### **1 & 2 station machines...**

##### **Accumulation: ON**

Accumulation is turned on for this job.

#### **3 station machines...**

##### **Accumulation From Main**

Accumulation is turned on with sheets feeding from the Main feeder. This feeder normally contains the address sheet.

##### **Accumulation From Suppl**

Accumulation is turned on with sheets feeding from the Supplementary feeder. i.e. one address sheet from the Main feeder followed by multiple sheets from the Supplementary feeder.

Press **Next (▶)** to advance to the next setting...

#### **Accumulation = (2 to 10)**

Select how many pages you want to feed into each envelope using **Change (+/-)**.

**Important:** The number of sheets that can be accumulated is limited by machine specifications. Exceeding this limit can cause machine malfunction. See page 4-14 for details.



## Setting the first/main Sheet Feeder

The machine will automatically select the first feeder to set, depending on the fold type selected.

**Note:** If you are collating different sheets using BOTH Sheet Feeders, the prime (addressed) document must be loaded into Sheet Feeder 1 for 'C' and **Double** Folds, and into Sheet Feeder 2 for 'Z' or **Single** Folds. If you only using a single sheet, either Sheet Feeder can be used, or you can use both utilising the 'Linked Feeder' feature described below.

Press **Change (+/-)** until you see the option you want:

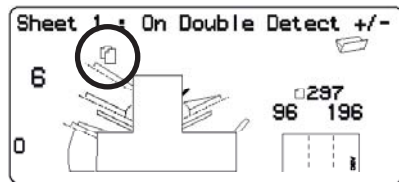

### On Double Detect

Feeder on with the double detector operating.

(The double detector stops the machine if more than one sheet simultaneously feeds from the feeder).

### Off

Feeder turned off for this job.



### On

Feeder on without the double detector.



### Manual Feed

Allows you to manually feed collated sets (only available on Sheet Feeder 1. Also, see notes on following page).



### Linked: On



### Linked: On Double Detect

These functions are available only on the three-station machine. Feed will initially be from the first Sheet Feeder. When the feeder is empty, the machine will automatically switch to feeding from the second Sheet Feeder.

When a trial piece is requested, both feeders must be loaded as a trial piece will be fed from each feeder.

continued...

## 2 • Operation

---

### Notes about manual feed:

1. The manual feed setting allows stapled sets of up to 5 sheets (to a maximum of 400g/m<sup>2</sup> per set) to be run. The maximum compressed thickness of the set *after folding* must not exceed 2mm. The machine will wait for manual insertion of each set into Sheet Feeder 1 after which it will fold and insert the set automatically.
2. When running manual feed mode, Sheet Feeder 2 becomes inoperable.

When the first Sheet Feeder is set as required, press **Next** (▶) to advance to the next setting...

### Setting the second/supplementary Sheet Feeder

Select whether you want to use the second Sheet Feeder.

Press **Change** (+/-) until you see the option you want:

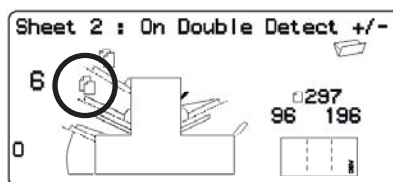

#### On Double Detect

Feeder on with the double detector operating. (The double detector stops the machine if more than one sheet simultaneously feeds from the feeder).



#### On

Feeder on without the double detector.

#### Off

Feeder turned off for this job.

When the second Sheet Feeder is set as required, press **Next** (▶) to advance to the next setting...

### Setting Insert Feeder

Select whether you want to use the Insert Feeder and, if so, how it will be used.

Press **Change (+/-)** until you see the option you want:

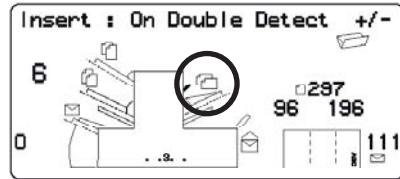

#### **On Double Detect**

Feeder on with the double detector operating. (The double detector stops the machine if more than one insert simultaneously feeds from the feeder).



#### **On**

Feeder on without the double detector.

#### **Off**

Feeder turned off for this job.

When the Insert Feeder is set as required, press **Next (▶)** to advance to the next setting...

### Mode

The machine needs to know if the job requires inserting into an envelope or if it is a fold only job.

Press **Change (+/-)** to switch between the options:

#### **Insertion Mode**

Activates the Envelope Feeder for a normal inserting job.

#### **Fold Only Mode**

Turns the Envelope Feeder off and makes the machine act as a folding machine.

When the mode is set as required, press **Next (▶)** to advance to the next setting...

## 2 • Operation

---

### Sealer

This setting only appears if an insertion mode has been selected.

Select whether you want to seal envelopes or not.

Press **Change (+/-)** to switch the option on or off:



#### On

Turns the sealer unit on for automatic sealing of envelopes. Make sure the sealer water bottle is full of Sealing Solution or water (see page 2-10).



#### Off

Turns the sealer unit off. Envelopes will be ejected unsealed.

When the sealer is set as required, press **Next (▶)** to advance to the next setting...

If you have selected either of the Sheet Feeders, the next setting offered will be Paper Length. However, if you are using the Insert Feeder only, folding is not possible and the display will advance directly to the Envelope Depth setting on page 2-18.

## Paper Length

Select the paper length.

Use the scale on the edge of the front cover.

Quick reference:

*A4 paper length 297mm*

*US Letter length 11" (279mm)*



Press **Change (+/-)** until the length of your paper (in millimetres) is displayed.

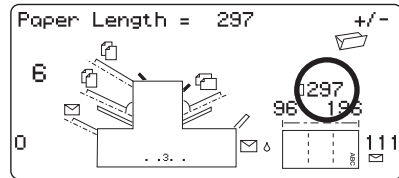

When the paper length is correct, press **Next (▶)** to advance to the next setting...

## Fold A

Select the size of the first fold required.

Depending on the settings previously made for fold type and paper length, the machine will be suggesting the correct dimension for the first fold. Most times, therefore, this setting will not require alteration.

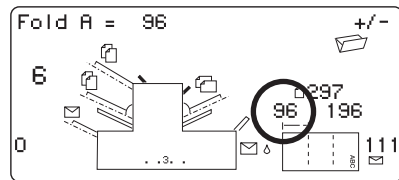

If you want to change the 'standard' setting, press **Change (+/-)** until the length of fold required is displayed. The symbol | — | shows the fold panel you are adjusting.

The machine will automatically limit your choices to what is physically possible within the machine specifications. (As you change the length of Fold A, you will see the dimension of Fold B automatically changing to keep within Paper Length and machine specifications.)

When the setting is correct, press **Next (▶)** to advance to the next setting...

## 2 • Operation

---

### **Fold B**

Select the size of the second fold required.

In a similar way to fold A, the machine will be suggesting the correct dimension for the fold.

If you want to change the 'standard' setting, press **Change (+/-)** until the length of fold required is displayed. The symbol  shows the fold panel you are adjusting.

When the setting is correct, press **Next (▶)** to advance to the next setting...

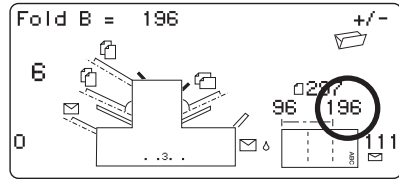

If you are programming an inserting job, the setting Envelope Depth will now appear. If you are programming a fold only job, the display will jump straight to the 'Confirming the Job Setup' section on page 2-20.

### **Envelope Depth**

Select the depth of your envelopes (in millimetres).

Again, you can use the scale on the front cover to measure the depth of your envelopes.

Press **Change (+/-)** until the correct dimension is displayed.

When the envelope depth is set as required, press **Next (▶)** to advance to the next setting...

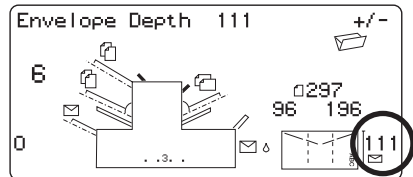

## Envelope Stop

Select the position of the machine's envelope stop.

The stop has five positions numbered 1 to 5. Setting 3 is the 'standard' setting for normal weight paper with standard folds.

A thinner/lighter insert will require a lower setting and thicker/heavier insert a higher setting.

Press **Change (+/-)** until the setting you want is displayed.

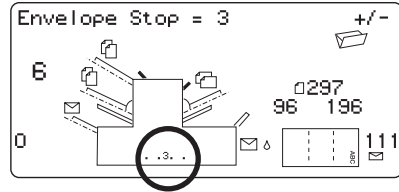

When the envelope stop is set as required, press **Next (▶)** to advance to the next set

## Batch Counter

The Batch Counter allows you to automatically process pre-defined batches of finished mailpieces. When the batch is complete, the machine will stop automatically. Pressing **Start** will commence processing of the next batch.

If Batch Counter is **not** selected, the display counter will simply count the number of items processed until reset by pressing **Reset Counter**.

Press **Change (+/-)** to switch Batch Mode On or Off.

When the setting is correct, press **Next (▶)**.

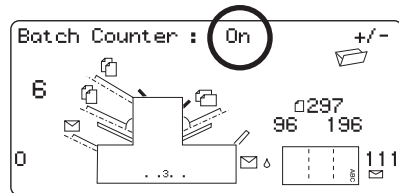

If Batch Counter is turned On, the machine will now request the batch quantity. The default quantity is 50, but you may select any value up to 999 using the **Change (+/-)** buttons.

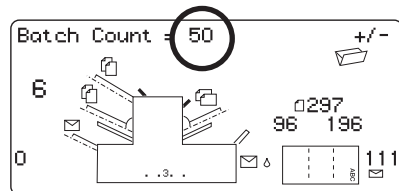

When the setting is correct, press **Next (▶)**.

## 2 • Operation

---

### Confirming the Job Setup

Job setup is now complete. The display will show the complete job setup for you to confirm.

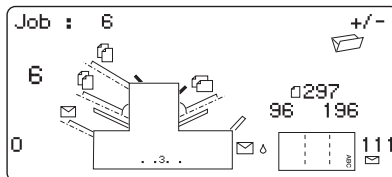

If you see a setting that is incorrect, use the **Prev** (◀) button to backtrack to the setting and correct it.

When you are satisfied with the job setup, press the **Setup** button. The machine will save the job into its memory and reset to the new job.

When this is complete, the display will show the new job with the message 'Trial Piece Required'.

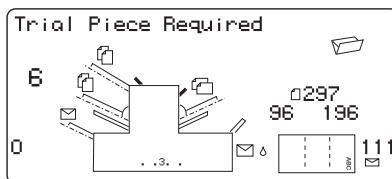

Job settings will be retained by the machine *even with power disconnected* until they are changed or deleted as described on the following page.



## Testing the Job

Load material and press **Trial Piece** so that you can check if the setup is correct.

Minor changes to the job settings can be made at this stage if the trial piece needs 'fine tuning'. Press Setup, then use the **Prev** (◀), **Next** (▶) and **Change (+/-)** buttons as required to modify job settings. A chart is provided on the following page to help 'fine tune' your fold settings.

FOLD TYPE	ADDRESS TOO LOW	ADDRESS TOO HIGH
"C" - Letter Fold	Decrease Fold A	Increase Fold A and increase Fold B by the same amount
"Z" - Accordion Fold	Increase Fold A	Decrease Fold A and increase Fold B by the same amount
Single Fold	Increase Fold A	Decrease Fold A
Double Fold	Decrease Fold A	Increase Fold A

It is recommended that the folds are changed by 5mm each time and a new trial piece run to test the settings.

When you have made the necessary changes, press **Setup** again to return to run mode. The job will be saved with the new settings.

## 2 • Operation

---

### Changing an existing job

To change an existing job...

1. Enter the setup mode as described on page 2-9.
2. Use the **Change (+/-)** buttons to display the job you wish to edit.
3. Use the **Prev (◀)** and **Next (▶)** buttons to display the setting(s) you wish to change.
4. Use the **Change (+/-)** buttons to change the options/dimensions you wish to amend.
5. Press the **Setup** button to leave setup mode and save the changes.

### Deleting a job

To erase an existing job from memory, follow the steps below:

1. Enter the setup mode as described on page 2-9.
2. Use the **Change (+/-)** buttons to display the job you wish to delete.
3. Press the **Delete** button. The display reads "Press again to confirm". Press **Delete** again. The display will briefly read 'Deleting Job' as the job is erased.
4. Press the **Setup** button to leave setup mode.

## OMR Availability

Your machine can be equipped with Optical Mark Recognition (OMR) functionality either on installation or as an added option after purchase.

All models have 20 Operator programmable jobs plus 1 default job set by the Service Engineer.

## What is OMR?

An OMR mark is normally a dark solid line on a sheet of light coloured paper that is perpendicular to the direction of travel of the paper. This line must be sufficiently thick and dense to trigger the OMR scanner on the system.

The OMR scanner, working with the OMR system software, checks for one or more different OMR marks on a document while it is fed through the system. The tracking of these OMR marks by the system increases the chance that a set of sheets which belong together (a set) actually stays together throughout the inserting process.

The **Prev** (◀) and **Next** (▶) buttons are used to step forward or backwards through the settings available. Once the item is displayed, the **Change (+/-)** buttons are used to select the option you want.

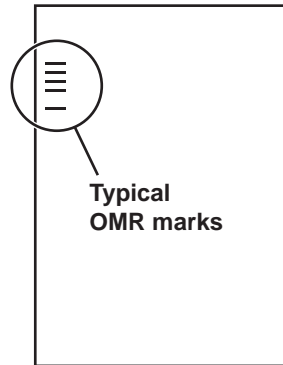

## A Brief Overview of OMR on your machine

One sheet feeder holds sheets with OMR marks:

- Sheet Feeder 1 for 'C' fold and Double fold
- Sheet Feeder 2 for 'Z' fold and Single fold

The sheet feeder holding the sheets with OMR marks can feed multiple sheets per envelope.

The sheet feeder not holding OMR sheets can hold supplementary sheets that you can place under the selective control of the OMR sheets.

You can also set up the insert feeder to be under the selective control of the OMR sheets. As a result, OMR can be used to fill an envelope with a variable number of sheets from one feeder, with or without a supplementary sheet and an insert.

A supplementary sheet and folded insert will be nested with the first sheet in the envelope. As OMR allows each envelope to contain tailored contents, the last sheet in the envelope will include address information for use with windowed envelopes to ensure that each set of sheets is addressed to the correct recipient.

OMR on this system uses extensive error checking to provide an extremely low possibility of the wrong set of sheets being inserted into an envelope.

### Levels of OMR on the system

**Basic OMR** enables you to collate multi-page documents that vary in number of sheets. It allows you to vary the number of pages per envelope in a run from one envelope to another through the use of OMR marks. The machine will fold each OMR sheet separately and insert it into an envelope, starting with the last sheet of the set and adding each folded sheet in turn until the address sheet has been inserted. The machine will then eject the envelope after sealing (if selected).

**Enhanced OMR** allows you to stop feeding sheets at selected points in a run and/or to select whether the other feeders are used. It also provides a higher level of mailpiece integrity so that sensitive documents are not sent to the wrong customer.

### OMR mark positions

To enable the OMR scanners fitted to the machine to be able to read the printed OMR marks, the marks must be positioned within a defined range of positions on the page.

**Standard** OMR positions are given in the diagram on page 3-4.

**Offset** OMR positions allow the marks to be positioned further down the page. Specifications are given in the diagram on page 3-5. To use Offset OMR, you must select one of the 'offset' OMR functions when programming the OMR job. See page 3-10 for full details.

## OMR Specifications

The mark must be a solid black line between 1pt and 2pts thick (0.35mm to 0.7mm) and at least 10mm wide.

Each mark position must be evenly spaced and at least 3mm apart.

An area around the marks should be kept clear from print, etc. that may be read by the scanner in error, this area is called the Clear Zone.

There should be no print on the opposing face of the sheet immediately behind the Clear Zone.

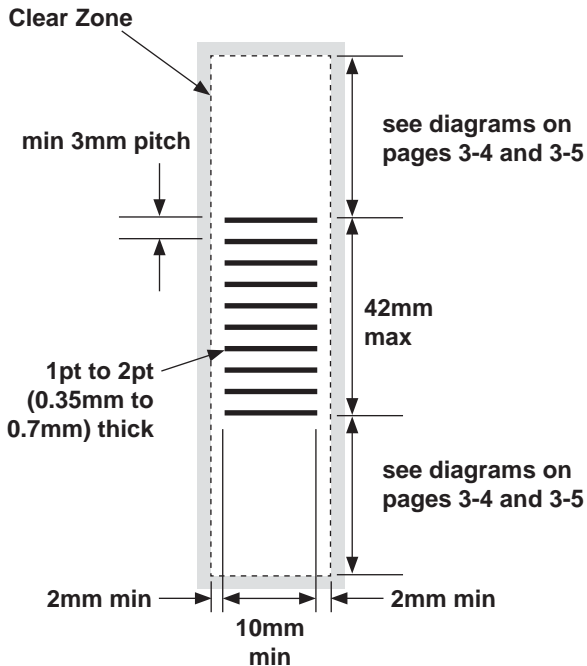
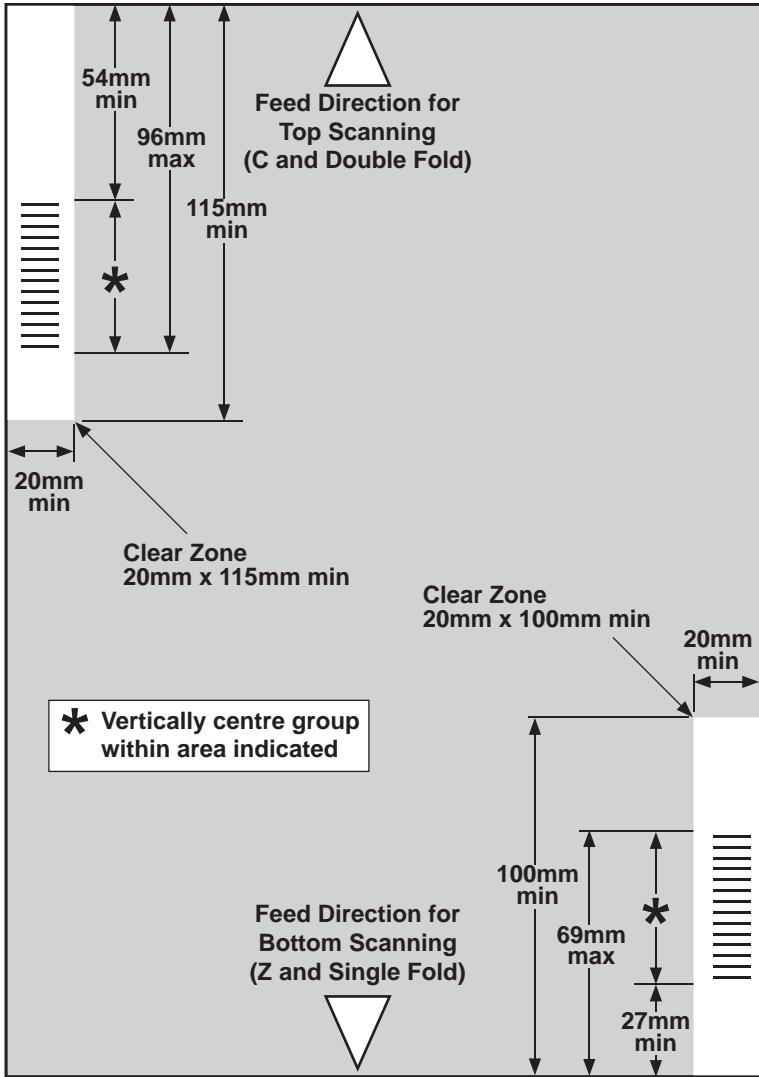

Diagram NOT to scale

**'Standard' OMR Positions**



OMR marks should be positioned as follows:

'C' Fold and Double Fold: TOP SCANNING, TOP LEFT CORNER

'Z' Fold and Single Fold: BOTTOM SCANNING, BOTTOM RIGHT CORNER

**Diagram NOT to scale**

**'Offset' OMR Positions**

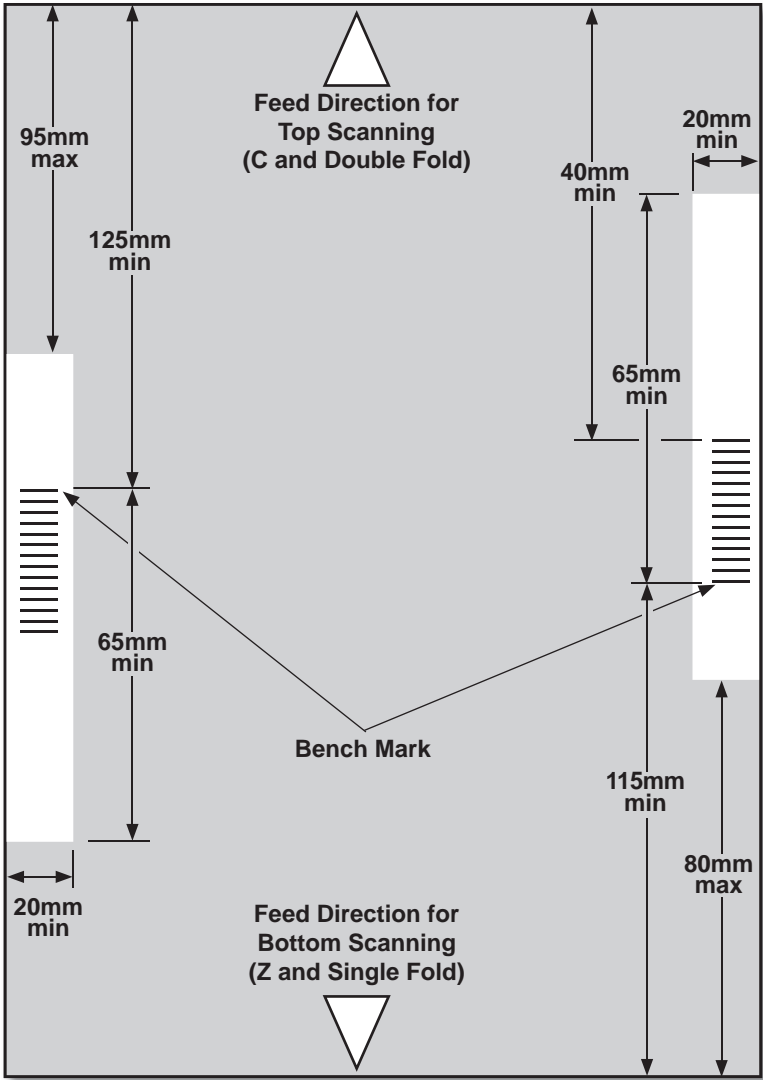

OMR marks should be positioned as follows:

'C' Fold and Double Fold: TOP SCANNING, LEFT MARGIN

'Z' Fold and Single Fold: BOTTOM SCANNING, RIGHT MARGIN

**Diagram NOT to scale**

### OMR Marks Available

This section gives brief descriptions of the OMR Marks that can or must be allocated to an OMR Code.

**Note:** Some marks within this section are available as added features which expand OMR capability. Contact your machine supplier for details. OMR features available will vary depending on the country you are in.

#### ***Benchmark***

This is a mandatory mark. It must be the *first* mark of the code and will appear on *every* page within the set.

#### ***Safety***

This is a mandatory mark that improves the integrity of your Mail Piece. It is automatically placed immediately after the Benchmark.

#### ***End of Collation (EOC)***

This mark indicates that it is the *last sheet fed within the collation/set* (the address sheet).

Your system operates on the **ABSENCE** of this mark. i.e. the action will take place if the mark is NOT read by the scanner. It is therefore indicated on the OMR code as '**Not EOC**'.

#### ***Beginning of Collation (BOC)***

This mark indicates that it is the *first sheet fed within the collation/set*.

Your system operates on the **ABSENCE** of this mark. i.e. the action will take place if the mark is NOT read by the scanner. It is therefore indicated on the OMR code as '**Not BOC**'.

#### ***Parity***

This mark is a *security feature*, that when printed always makes the number of marks total an even number. If any one of the marks within the code is missed during scanning, the machine will stop functioning, allowing the error to be rectified.



### **Retiming Mark**

This mark is mandatory in each group of OMR marks making up the code (see later in this section for an explanation of OMR mark grouping).

It allows the machine to recalibrate for accurate scanning. Retiming marks count in the parity calculation.

### **Select Feed (SF1, SF2)**

These marks are used to *control the feed of material from the feeder holding the supplementary sheets/inserts* on a set by set basis. Select Feed cannot therefore be used on a 1 station machine.

**Select Feed 1** marks are used in the **primary** sheet feeder to select material from the **supplementary** sheet feeder. i.e. For 'C' and Double fold, the primary feeder is Sheet Feeder 1. For 'Z' and Single fold, the primary feeder is Sheet Feeder 2.

**Select Feed 2** marks are used in the **primary** sheet feeder to select material from the **Insert** feeder. i.e. For 'C' and Double fold, the primary feeder is Sheet Feeder 1. For 'Z' and Single fold, the primary feeder is Sheet Feeder 2.

### **Auto Batch**

This mark identifies the last set of a batch, when the batch function is in use. It must be printed on all sheets of the OMR set that requests this function.

### **Wrap Around Sequence (WAS1, WAS2, WAS3)**

This is a numbering system which uses a *sequential binary coding*. If a page becomes missing or the set becomes out of sequential order, the system will stop processing and declare an error message.

3 Wrap Around Sequence marks are used within the code. The use of 3 binary digits allows a decimal count of 0 to 7 to be achieved. Pages will be numbered from 0 up to 7 and then back to 0 on a continuous cycle throughout the print run.

## OMR Mark Grouping

Each OMR code begins with two fixed marks at the end nearest to the sensor (Benchmark and Safety mark). These are followed by one, two, or three groups of marks where each group comprises three data marks followed by a fixed mark. Each data mark is present or absent as required to reflect the desired function. Each code must end with a Retiming Mark.

Basic OMR mode uses only Group 1.

Enhanced OMR mode uses Group 1 plus Group 2 and/or Group 3, as needed for a particular job.

### 'C' Fold and Double Fold jobs

Marks must be placed in the upper left corner of the sheet. The marks must be printed in the top-to-bottom order:

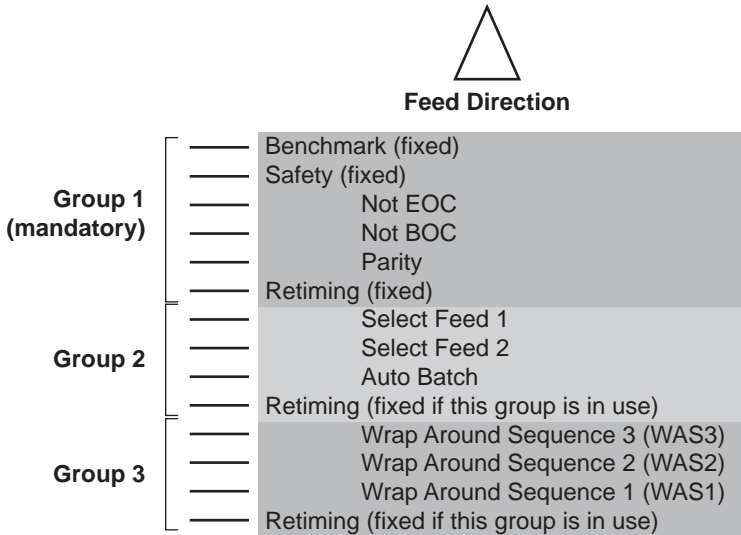

Sheets must be printed in reverse collation order. Therefore, the last sheet processed in each set is the address sheet and the first sheet processed is the last of each set.

**'Z' Fold and Single Fold jobs**

Marks must be placed in the lower right corner of the sheet. The marks must be printed in the bottom-to-top order:

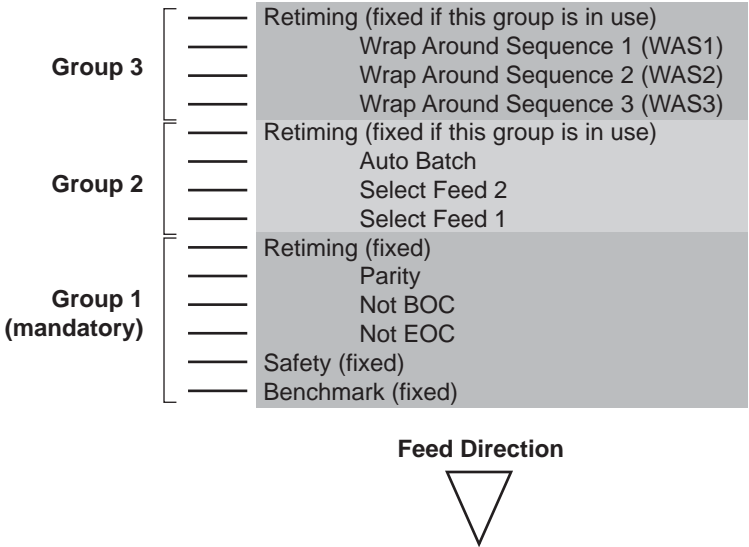

Sheets must be printed in normal collation order. Therefore, the first sheet processed in each set is the address sheet and the last sheet processed is the last of each set.

## Programming an OMR Job

### Entering the Setup Mode

Open the hinged cover to the right of the display. This will expose the setup buttons.

Press **Setup**. The indicator will light and the machine will ask for an access code. This code prevents the machine's settings being changed by unauthorised personnel.

Use the **Change (+/-)** buttons to select the access code **71**.

Press Next (▶) to advance to the next setting...

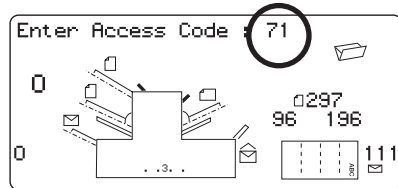

### Choosing the new job number

The machine will ask for the job number you wish the new settings to be stored under. Use the **Change (+/-)** buttons to display the job number you want.

#### Notes:

- If you use an existing job number, the old settings will be overwritten by the new settings you are about to make.
- If you want to find a currently unused job number, press **Change (+/-)** until you see a job where the display shows no symbols alongside the feeders or in the fold setup area. This means the job is currently empty.

Press **Next (▶)** to advance to the next setting...

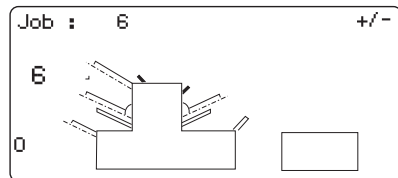
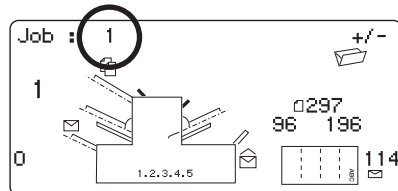

**Selecting the OMR functions**

Press **Change (+/-)** until you see the option you want. Note that the options shown will depend on the OMR functionality that your machine has. Details of 'standard' and 'offset' OMR positioning are given on pages 3-4 and 3-5.

**OMR off**

OMR is turned off for this job.

**OMR on**

OMR is turned on (Basic Scanning) for this job with 'standard' OMR mark positioning.

**OMR + Sequence**

Basic scanning + Wrap Around Sequence scanning for this job with 'standard' OMR mark positioning.

**OMR + Select feed**

Basic scanning + Select Feed/Autobatch scanning for this job with 'standard' OMR mark positioning.

**OMR + Select feed + Sequence**

Basic scanning + Select Feed/Autobatch + Wrap Around Sequence scanning for this job with 'standard' OMR mark positioning.

**OMR Offset on**

OMR is turned on (Basic Scanning) for this job with 'offset' OMR mark positioning.

**OMR Offset + Sequence**

Basic scanning + Wrap Around Sequence scanning for this job with 'offset' OMR mark positioning.

**OMR Offset + Select feed**

Basic scanning + Select Feed/Autobatch scanning for this job with 'offset' OMR mark positioning.

**OMR Offset + SF + Sequence**

Basic scanning + Select Feed/Autobatch + Wrap Around Sequence scanning for this job with 'offset' OMR mark positioning.

---

**continued...**

## 3 • OMR

---

### Notes:

**OMR (Basic scanning)** offers the following scanning functions:

- Benchmark
- Safety
- End of Collation absent
- Beginning of collation absent
- Parity
- Retime

**Select feed/autobatch** offers the following scanning functions:

- Select feed 1
- Select feed 2
- Autobatch
- Retime

**Sequence** offers:

- Three wrap around page sequence marks
- Retime

The maximum pages per set that can be fed from either Sheet feeder 1 or 2 when using the OMR function must fall within the limits detailed on page 4-14 of this guide.

Press **Next** (▶) to advance to the next setting...

**Fold Type**

Select the type of fold.

Press **Change (+/-)** until you see the option you want:

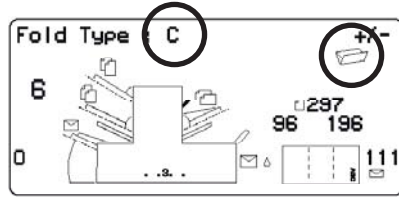

**Note:** For OMR scanning jobs, **DO NOT** manually change the automatically set fold length dimensions for 'Fold A' and 'Fold B'

**C - Letter**

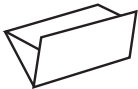

**Z - Accordion**

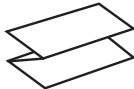

**Double**

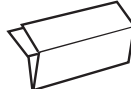

**Single**

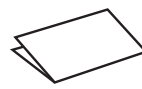

When you select either 'C' Fold or a Double Fold, the machine will automatically select the TOP **Sheet Feeder 1** as the scanning feeder. If you select either a 'Z' Fold or a Single Fold, the machine will automatically select the BOTTOM **Sheet Feeder 2** as the scanning feeder.

The display will indicate the correct orientation of the paper for loading into the feeders:

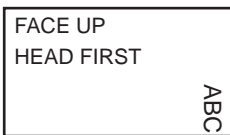

When the fold type is set as required, press **Next (▶)** to advance to the next setting...

### 3 • OMR

---

#### **Setting the Main (scanning) Sheet Feeder**

Press **Change (+/-)** until you see the option you want:

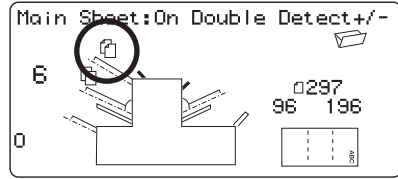

#### ***On Double Detect***

Feeder on with the double detector operating. (The double detector stops the machine if more than one sheet simultaneously feeds from the feeder).



#### **On**

Feeder on without the double detector.

When the Sheet Feeder is set as required, press **Next (▶)** to advance to the next setting...



## Setting Select/Supplementary Feeders

Press **Change (+/-)** until you see the option you want:

If **Sheet Feeder 1** is the main/scanning feeder, **Sheet Feeder 2** and/or the **Insert Feeder** can be programmed for normal (1 per envelope) feeding or select feeding.

If **Sheet Feeder 2** is the main/scanning feeder, **Sheet Feeder 1** and/or the **Insert Feeder** can be programmed for normal (1 per envelope) feeding or select feeding.

Select feed allows for one piece to be *selectively* fed from either feeder per envelope.

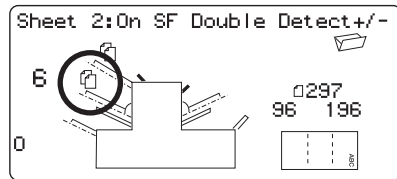

### On Double Detect

Feeder on with the double detector operating, without select feed. (The double detector stops the machine if more than one sheet simultaneously feeds from the feeder).



### On SF Double Detect

Select Feeder on with the double detector operating. (The double detector stops the machine if more than one sheet simultaneously feeds from the feeder).



### On SF

Select Feeder on without the double detector.

### Off

Feeder turned off for this job.



### On

Feeder on without the double detector or select feed.

When the feeder is set as required, pressing **Next (▶)** will advance to the Sealer setting. Job programming then follows the normal sequence described from page 2-16 of this guide.

## 3 • OMR

---

### Adjustment of OMR scanner

In order for the OMR Scanning to function correctly, it is important to ensure that the Scanning heads are positioned in line with the Scan Dash marks printed on the material.

In order to locate the Scanning head for the TOP Sheet Feeder 1, open the Top Cover. The Scanning head can be found at the rear of the machine.

In order to locate the Scanning head for the BOTTOM Sheet Feeder 2, remove both Sheet Feeder 2 and the Fold Plate situated below Sheet Feeder 2. The Scanning head can be found mounted to the front of the machine.

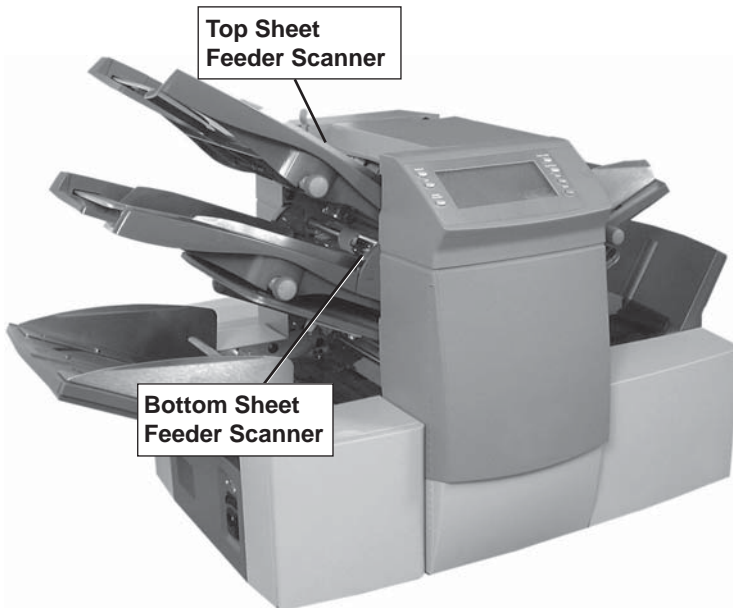

Fold a sheet of material IN HALF and measure the distance from the side of the form to the middle as shown.

For an A4 size form, this measurement is 105mm.

Now measure the distance from the edge of the form to the middle of the scan dash marks, as shown, and subtract this measurement from the half fold measurement.

**Example:**

For an A4 size form, the half fold measurement is **105mm**.

If the distance from the edge of the form to the middle of the scan dash marks is **10mm**, the Scanning Head setting will be **95mm** (105mm – 10mm).

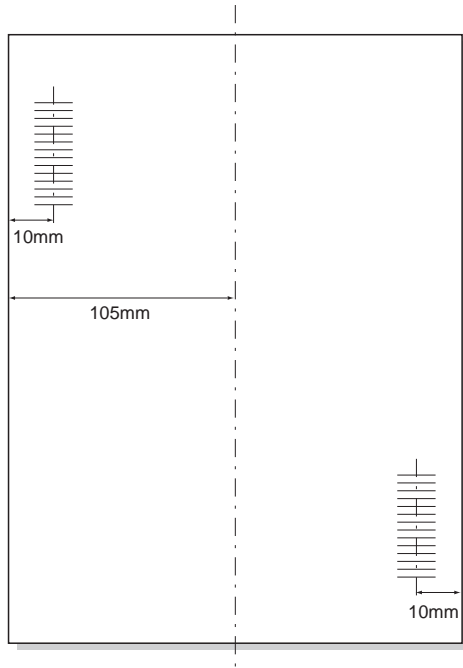

Loosen the knurled locking knob and set the relevant scanning head to the correct setting.

Retighten the locking knob.

If you have adjusted the bottom sheet feeder scanner, refit both Sheet Feeder 2 and the Fold Plate situated below Sheet Feeder 2.

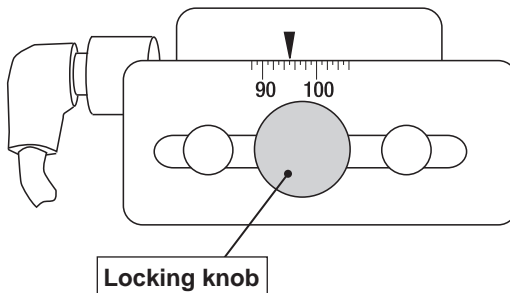

## OMR Troubleshooting

### ***Error Recovery for OMR jobs:***

If the machine stops during an OMR job, and indicates one of the error messages listed below, press the **Clear Deck** key. Any envelope at the insertion area will eject into the stacker. The remaining pages of the current set will feed/fold and eject into the stacker, and can be manually inserted into the envelope. The FIRST page of the NEXT set will prefeed into the feed rollers and stop. Pull back the sheet to the normal feed position and continue to run.

### ***Error Recovery for Accumulation jobs:***

If the machine stops during an Accumulation job, press the **Clear Deck** key. The envelope at the insertion area will eject into the stacker. It is necessary to MANUALLY remove the remaining pages of the set from the appropriate feeder and fold/insert into the envelope. Then continue to run once the cause of the stoppage has been determined.

### ***Error Recovery for empty Feeders:***

If any feeder runs out of material the machine will stop, and the following messages will scroll across the display...

“Re-fill Empty Tray”

then... “Press START to Continue”

or... “Press STOP and Clear Deck”

Reload the Feeders and proceed as required.

### ***OMR Error Messages***

<b><i>Message</i></b>	<b><i>Action</i></b>
Bad OMR marks Spacing	Two marks are read which are closer together than half the expected distance. Check scan marks on material.
No OMR marks	No marks on paper. Scan sensor not positioned centrally over the scan marks. Paper not loaded correctly.

<b>Message</b>	<b>Action</b>
Bad OMR Code length	Code type on paper does not match the setup. Example: setup has OMR+ Sequence but paper has OMR + Select Feed + Sequence.
Bad OMR Code format	A re-timing scan mark is missing. Check material. Example: mark 6 is missing from a 10 mark code.
Expected 1st Sheet of set	The BOC mark (position 4) was present when it was not expected. First page of the set was expected.
Not a new Envelope	The BOC mark (position 4) was absent when it was expected. Pages other than the first page of the set were expected.
OMR: Parity Error	The code does not have an EVEN number of marks.
OMR: Sequence Error	The sequence number is not sequential with the previous page fed. Sheets are in the wrong order or missing.
OMR: SF marks Inconsistent	The Selective feed and Autobatch marks at positions 7 to 9 are different to those on the previous sheet of this set.
OMR: SF not in Use	A selective feed mark is present at positions 7 to 8, but the job setup does not include select feed.
OMR: Set too Large	The set contains too many sheets from the main feeder.
OMR: End of Batch Ready to Run	This indicates that the machine has stopped for "End of Batch". Allows the operator to manually sort the envelopes.
Mode Change Recheck Feeders	It is necessary to check the Sheet and Insert Feeder settings against the job you are loading before exiting the set up mode.



## Changing the Display Language

To change the language of the display...

1. Open the hinged cover to the right of the display. This will expose the setup buttons. Press **Setup**. The indicator will light and the machine will ask for an access code.
2. Use the **Change (+/-)** buttons to select the access code **99**.
3. Press **Next (▶)** to select the languages option.
4. Use the **Change (+/-)** buttons to scroll through the languages. When your required language is displayed, press the **Setup** button to select the language and leave setup mode

## Clearing Material

**Note:** All the following illustrations show the three-station machine, although all models are similar.

The machine has been designed to assure maximum performance. In the event of a material stoppage, the display will flash the symbol indicating where the stoppage has occurred. First press **Clear Deck** to attempt to feed the material through the machine. If not successful, the sections below tell you how to remove the trays and plates to gain access to the material.

### *The Manual Advance Knob*

Having located the material, you may need to use the Manual Advance Knob to manually feed paper out of the grip of rollers etc.



The Manual Advance Knob is located behind the drop down cover at the left front of the machine.

## 4 • Reference

---

### **Removal & Replacement of the Sheet Feeder Trays**

*To remove...*

Lift the rear of the tray slightly and pull it straight outwards from the machine.

**Note:**

If the tray is loaded, gently hold the material in place to prevent it sliding forward as the tray is removed.



*To replace...*

Place the tray into its location guides in the side frames. Lift the rear of the tray slightly and push it into the machine. The tray will automatically drop into its correct location.

### **Removal & Replacement of the Fold Plates**

*To remove...*

Pull the two catches on the underside of the plate outwards to release them. Pull the plate straight out from the machine.

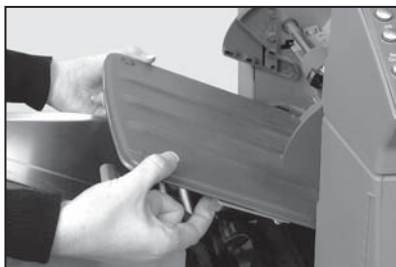

*To replace...*

Pull the two catches on the underside of the plate outwards to release them. Slide the plate into its location guides and release the catches to lock the plate in position.

### **Removal & Replacement of the Insert Tray**

*To remove...*

Pull the insert tray straight outwards from the machine.

*To replace...*

Slide the tray into its location guides and push until it 'clicks' into place.





### ***Access to Carriage Assembly***

(2 and 3 station machines only).

The carriage assembly can be pulled outwards to gain access. The Insert Feeder and Fold Plate 2 must be removed first.

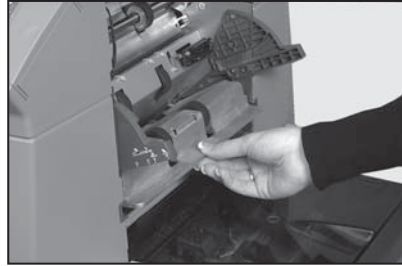

### ***Access to Envelope Feeder Area***

*To gain access...*

Pull the release lever in the direction of the arrow.

Lift the envelope area feed rollers to gain access.

*To relatch feed rollers...*

Release the envelope area feed rollers and let them rest in position.

Push the rollers firmly down until they latch into position.

**Note:** Access to this area can be improved by removing Fold Plate 1 and Sheet Feeder 2.

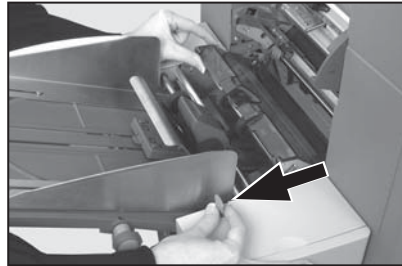

### ***Access to the Envelope Exit Area***

Pull down the access door as shown to gain access to jammed material.

When closing the access door, make sure it is firmly latched into position.

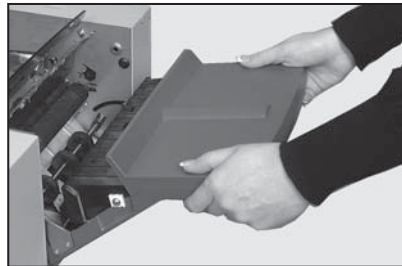

## 4 • Reference

---

### ***Access to the Envelope Inserting/Sealing Area***

Access can also be gained to the insertion and sealing areas by lifting the tinted plastic cover and lowering the envelope inverter access door.



### ***Access to the Sheet Feed Area***

*To gain access...*

Open the Top Cover.

Squeeze the two blue handles together and pivot the guide assembly to the right to gain access.

*To relatch...*

Squeeze the two blue handles together and pivot the guide assembly back to its closed position. Release the two blue handles making sure the assembly is securely latched into position.

Close the Top Cover.



## General Troubleshooting

<i>Problem</i>	<i>Remedy</i>	<i>Page</i>
<b>MACHINE</b>		
<b>Blank screen</b>		
No power.	Check power cord is firmly connected and wall socket is switched ON.	1-1
Machine not switched ON.	Turn power switch (located on left side) ON.	2-1
<b>Machine will not operate</b>		
Cover open.	Check that ALL covers are closed - check display for cover information.	
Feed trays/fold plates not located correctly.	Remove and relocate all feeders and fold plates firmly.	4-2
<b>Insertion Problems</b>		
Outer Envelope contents do not enter the envelope correctly.	Check envelope troubleshooting table.	4-6
	Check the fold selected is correct for the material size being run.	2-17 2-18
	If running heavy or light material, the Envelope Stop Adjustment might need changing.	2-19

## 4 • Reference

---

<i>Problem</i>	<i>Remedy</i>	<i>Page</i>
<b>ENVELOPES</b>		
<b>Poor Envelope Feed</b>		
Envelope side guides set incorrectly.	Set guides to envelope width and back off 1/2 turn.	2-6
Poor envelope quality.	Check envelopes are not curled. Try a new box of envelopes. Make sure stack has been fanned before loading.	4-15 2-6
Envelopes loaded incorrectly.	Load envelopes flap side up with the flap feeding last.	2-6
<b>Envelopes Fail to Open</b>		
Envelopes loaded incorrectly.	The lead edge of the envelope should be under the front feed rollers. Load envelopes flaps up and trailing.	2-6
Poor envelope quality.	Check envelopes are not stuck due to excessive dampness. Try a new box of envelopes.	4-15
<b>Envelope Sealing Problems</b>		
No sealing solution.	Refill Sealer Unit.	2-8
Seal mode not selected.	Check job setup. Activate sealing mode.	2-16

<b>Problem</b>	<b>Remedy</b>	<b>Page</b>
<b>SHEETS</b>		
<b>Poor Sheet Feed</b>		
Feeder not selected to feed.	Check job setup.	2-13
Sheet Feeder side guides set incorrectly.	Set guides to Sheet width and back off 1/4 turn.	2-4
Sheets loaded incorrectly.	Make sure stack has been fanned before loading.	2-4
<b>Multiple sheets feed when one is expected</b>		
Manual Feed mode is selected.	Check job setup and Manual Feed Lever position.	2-2
Sheets loaded incorrectly.	Make sure stack has been fanned before loading.	2-4
<b>Address in wrong position in envelope window</b>		
Address bearing sheets incorrectly loaded.	Load sheets so that the address appears through the envelope window.	2-4
Folds incorrectly set.	Check job setup.	2-17 2-18
<b>Poor Folding</b>		
A fold is <i>almost</i> corresponding with a perforation on the sheet, causing a 'box fold' or third fold.	Adjust the fold sizes slightly to avoid this situation.	2-17 2-18

## 4 • Reference

---

<i>Problem</i>	<i>Remedy</i>	<i>Page</i>
<b>INSERTS</b>		
<b>Poor Insert Feed</b>		
Feeder not selected to feed.	Check job setup.	2-3, 2-20
Insert Feeder side guides set incorrectly.	Set guides to Insert width and back off 1/4 turn.	2-6
Insert Feeder separator adjustments incorrect.	Make sure the two Insert Feeder adjustments (lever and separator shield) are set correctly for the type of Insert being run.	2-7
Inserts loaded incorrectly.	Make sure stack has been fanned before loading. Changing the orientation of the Insert stack may help.	2-7
Insert Feeder Wedge used incorrectly.	Let the Wedge slide down behind the Insert stack to support it.	2-7
Inserts out of specification.	Check specifications in this guide.	4-15

<i>Problem</i>	<i>Remedy</i>	<i>Page</i>
<b>DOUBLE DETECT</b>		
<b>Machine stops for 'doubles' that aren't there or feeds 'doubles' without stopping</b>		
Double Detect is not turned ON.	Check Double Detect status. Double Detect icon  will appear alongside all items where Double Detect is operational. Correct loading or correct job setup as necessary.	Chapter 2
Double Detect is not correctly calibrated.	Run a Trial Piece whenever a new batch of material is loaded to recalibrate Double Detect. The new batch might be of slightly different thickness.	2-3

## 4 • Reference

---

### Error Messages

<b>Message</b>	<b>Action</b>
CALL SERVICE	Power machine off and on. If message is still displayed, call service.
CHECK /CLEAR FEEDER	Feeder indicated has failed to feed material. Remove material from the feed tray, reload and restart machine.
CHECK FEEDER	Feeder indicated is not located correctly. Remove tray and relocate. Also check loading of material in indicated feeder.
CHECK FOLD PLATE	Fold plate indicated is not located correctly. Remove Fold Plate and relocate.
CHECK INVERTER	Envelope inverter unit has not set to its correct position. Open inverter cover and check for any material. Close cover and restart.
CHECK LAST MAIL PIECE	Envelope has failed to open. Check envelopes are loaded correctly. Reload envelopes and restart machine.
CLEAR FOLD PLATE	Material has been detected inside the Fold Plate indicated on the display. Remove Fold Plate and check for any material. Refit Fold Plate.
CLEAR INSERTION AREA	Material has been detected in the inserting area. Open tinted plastic cover on left hand side of machine and remove any material. Close cover and restart.
CLEAR MOISTENER	Material has been detected in the sealer brush area. Open tinted plastic cover on left hand side of machine and remove any material. Close cover and restart.
CLEAR SEALER	Material has been detected in the sealer brush area. Open tinted plastic cover on left hand side of machine and remove any material. Close cover and restart.
CLOSE COVER	Cover indicated is not fully closed. Close indicated cover and restart.



<i>Message</i>	<i>Action</i>
MANUAL ADVANCE COVER OPEN	The Manual Advance Knob door is not fully closed. Close door.
DEFLECTOR ERROR	The function of half fold is not be possible due to a fault. Remove Fold Plates and check for any material.
DOUBLE FEED	A double feed has been detected being fed from the feed tray indicated. Remove the material from the machine and restart. If double feeds persist, request another trial piece.
DOUBLE FEED CHECK STACKER	A double feed has been detected being fed from the feed tray indicated. Remove the double feed from the stacker. Restart machine.
FOLD PLATES NOT SET	The Fold Plates has not set to the correct position. Remove Fold Plates and check for any material. Refit Fold Plates and restart.
MANUAL FEED TIMEOUT	Material has not been detected being fed from the feeder. In manual feed mode, the material must be fed by a set time. Restart the machine by pressing <b>Start</b> .
PAPER SHORT	The material being used has been detected to be too short in length. Check material length being used matches the length displayed. If correct, request another trial piece.
PAPER SHORT CHECK STACKER	The material being used has been detected to be too short in length. Check material length being used matches the length displayed. If correct, request another trial piece.
SET LEVER	Manual feed lever in the incorrect position for the mode of running. Move the manual feed lever to the correct position. (Left position:manual, Right:automatic).
STREAM FEED	The machine has detected two sheets being fed together from the feed tray indicated. Remove material from the machine, reload and restart machine.

## 4 • Reference

---

<i>Message</i>	<i>Action</i>
STREAM FEED CHECK STACKER	The machine has detected two sheets being fed together from the feed tray indicated. Remove the stream feed from the stacker. Reload machine and restart.
SYSTEM ERROR POWER DOWN	A fault has been detected in the main software. Switch machine off and on and retry. If problem persists, call service.
TRAY EMPTY	Tray indicated has no material. Reload tray and press <b>Start</b> .

## Material Specifications

### Sheet Feeders

**Minimum sheet size:** 127mm Width  
127mm Length

**Maximum sheet size:** 229mm Width  
406mm Length

**Paper weights:** 60g/m<sup>2</sup> Minimum (non OMR)  
70g/m<sup>2</sup> Minimum (OMR)  
120g/m<sup>2</sup> Maximum

**Fold configurations:** Material length limits before folding

Single fold: 127mm - 315mm

“C” - Letter fold: 150mm - 356mm

“Z” - Accordion fold: 201mm - 356mm

Double fold: 305mm - 406mm

**Double Document Detector Material range:** 60g/m<sup>2</sup> (16 lb) Min  
120g/m<sup>2</sup> (32 lb) Max

**Feed tray capacity:** Up to a maximum of 325 sheets of 80g/m<sup>2</sup>

**Manual Feed Mode:** Stapled sets up to 5 sheets of 80g/m<sup>2</sup> to a maximum total weight of 400g/m<sup>2</sup> per set can be processed in the Manual Feed Mode. **Only Sheet Feeder number 1 (plus the Insert Feeder if required), can be used for Manual Feed applications.** The maximum compressed thickness after folding should not exceed 2mm. Glossy/coated sheets are not recommended.

## 4 • Reference

---

### **Fold Type and Overall Thickness Limits**

The table below shows the maximum number of sheets that can be accumulated or collated for each fold type, based on different weights of paper.

**It is important that jobs exceeding these maximums are NOT programmed into the machine or imposed by OMR code printing and/or OMR selective feed.**

Number of sheets	Paper Weights in g/m <sup>2</sup>		
	60-80	81-100	101-120
1	C,Z,S,D	C,Z,S,D	C,Z,S,D
2	C,Z,S,D	C,Z,S,D	C,Z,S
3	C,Z,S,D	C,Z,S	C,Z,S
4	C,Z,S	C,Z,S	
5	C,Z,S		

Fold Types: C = C Fold, Z = Z Fold, S = Single Fold, D = Double Fold

The sheet limits above can be used with 1 additional sheet from the Supplementary Feeder plus 1 Insert, only if the total Mail Piece contents are up to a maximum of 2mm total compressed thickness.

For SINGLE Fold ONLY using 60-75g/m<sup>2</sup> paper ONLY, up to 10 items can be placed into an envelope. This 10 item maximum INCLUDES any additional sheet from the Supplementary Feeder and/or Insert. The overall maximum compressed thickness of 2mm still applies.

### ***Insert Feeder***

**Minimum Insert size:** 127mm Width  
82mm Length

**Maximum Insert size:** 230mm Width  
152mm Length

**Paper Weights:** 75g/m<sup>2</sup> Minimum (non-folded cut sheet)  
180g/m<sup>2</sup> Maximum (Single Sheet)  
60g/m<sup>2</sup> Minimum (folded material)

And Inserts of up to a maximum  
compressed thickness of 2mm.

Pre-folded or single panel Inserts should be fed from the Insert Feeder.

**Double Document Detector Material range:** 60g/m<sup>2</sup> Minimum  
120g/m<sup>2</sup> Maximum

**Feed tray capacity:** Up to a maximum of 100 Inserts

### ***Sealer***

The machine can seal up to a maximum of 1200 envelopes between refills.

### ***Stacker***

The envelope Stacker can accommodate up to 150 filled envelopes. (Dependent on size and contents of the envelope).

### ***Material Requirements***

For best performance, use only materials approved by Pitney Bowes. Materials should be good quality and properly stored.

Recommended storage conditions: 18°C (65°F) to 25°C (77°F)  
40% to 60% relative  
humidity

## 4 • Reference

### Envelope Feeder

**Minimum envelope size:**

88mm Depth  
220mm Width

**Maximum envelope size:**

164mm Depth  
242mm Width

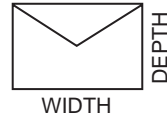

**Envelope weights:**

65g/m<sup>2</sup> Minimum  
100g/m<sup>2</sup> Maximum

**Envelope tray capacity:**

Up to a maximum of 100 90g/m<sup>2</sup> envelopes

**End Clearance:**

End clearance between the Insert and envelope is a minimum of 6mm at each side i.e. a minimum of 12mm overall. This measurement should be taken with all documents placed into the envelope.

**Depth Clearance:**

The Insert must allow a minimum clearance of 3mm for unfolded documents, and 6mm for folded documents, below the flap crease after it is fully inserted into the envelope.

**Envelope flap and throat requirements:**

See illustration below

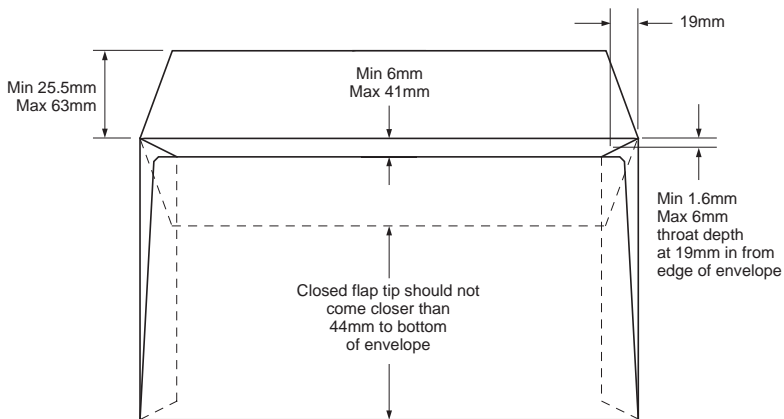

**ALL SPECIFICATIONS ARE SUBJECT TO CHANGE WITHOUT NOTIFICATION AND ARE SUBJECT TO TEST**

## Machine Specifications

### Physical Dimensions:

Length	773mm
Depth	568mm
Height	525mm
Weight	55kg

**Noise Level (Running):** 73dBA

**Electrical:** 230V, 50Hz, 3A  
or 110V, 60Hz, 6A

### Speed:

Up to a maximum of 3,000 cycles per hour (depending on fold type and material quality)

**Fold Modes:** Single fold  
“C” - Letter fold  
“Z” - Accordion fold  
Double fold

### Compliance:



Pitney Bowes certifies that the Inserting System complies with the requirements of the Low Voltage Directive 73/23/EEC and the EMC Directive 89/336/EEC. The product was tested in a typical configuration.

For a formal Declaration of Conformity please contact Compliance Engineering on +44 (0)1279 426731.

## Service

Service for your new Folding/Inserting machine is available throughout the world.

Should you have questions about your machine, or require service or assistance with your particular application, please call your machine supplier.

Your machine supplier will also offer a service maintenance contract to keep your machine in top condition at nominal cost.

Contact details can be found:

- On the separate leaflet supplied with your system.
- or
- On the rear of this guide.

## 4 • Reference

---



**Jobs**

Use the table below to keep a note of the jobs you have programmed into the system:

<b><i>Job</i></b>	<b><i>Description</i></b>
<b>Default</b>	
<b>1</b>	
<b>2</b>	
<b>3</b>	
<b>4</b>	
<b>5</b>	
<b>6</b>	
<b>7</b>	
<b>8</b>	
<b>9</b>	

# JOBS

---

<b>Job</b>	<b>Description</b>
<b>10</b>	
<b>11</b>	
<b>12</b>	
<b>13</b>	
<b>14</b>	
<b>15</b>	
<b>16</b>	
<b>17</b>	
<b>18</b>	
<b>19</b>	
<b>20</b>	





*Engineering the flow of communication™*

The Pinnacles,  
Harlow, Essex, CM19 5BD, UK  
[www.pitneybowes.co.uk](http://www.pitneybowes.co.uk)

For Service and Supplies



PB Form SDC639A (2-06)

© Pitney Bowes Limited, 2006

We have made every reasonable effort to assure the accuracy and usefulness of this guide, however we cannot assume responsibility for errors or omissions or liability for the misuse or misapplication of our products.

Printed in the UK



Printed on recyclable paper



\* S D C 6 3 9 A \*